

K/k: Schau genau!

Klebe richtig dazu!

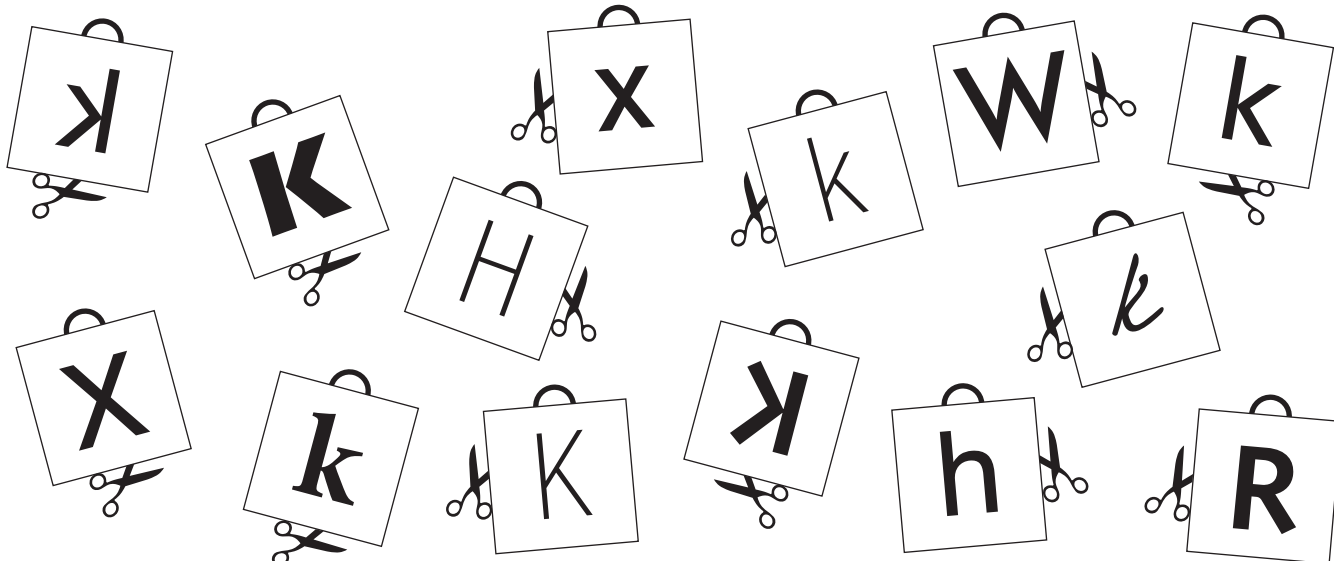
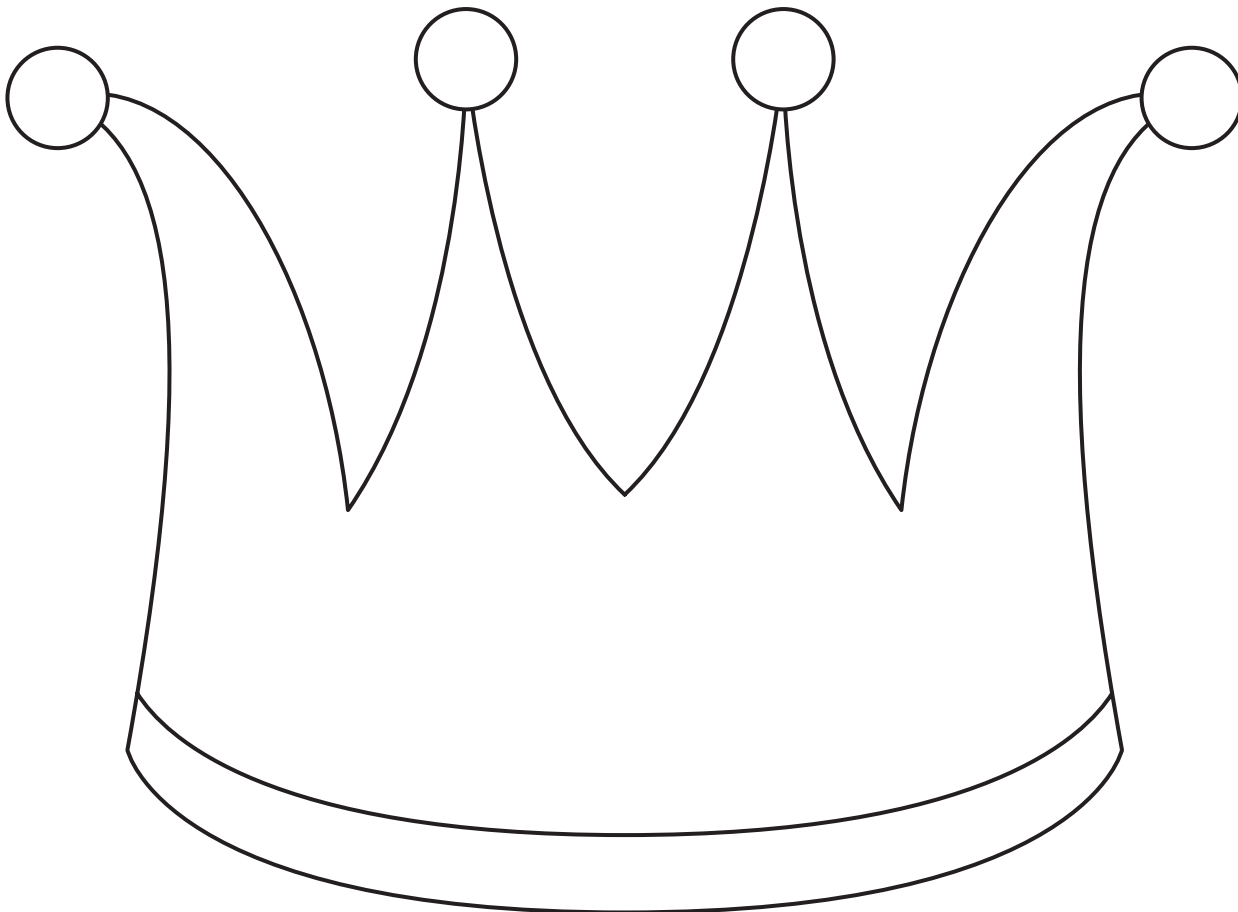

Wo hörst du K/k?

Kreuze richtig an!



		

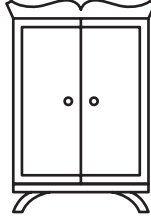

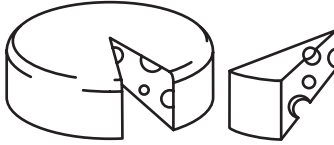

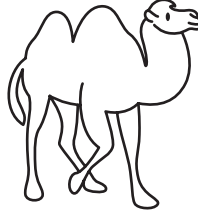

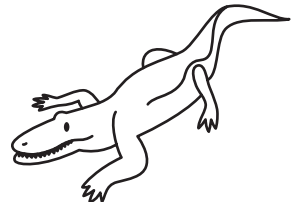
Was passt oben?

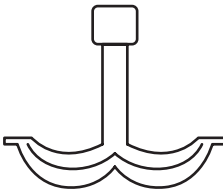
X		
	X	
X	X	
X		

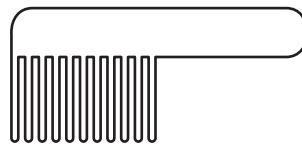

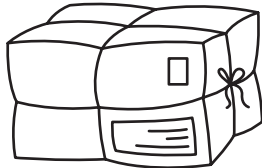
	X	
		X
X		
		X

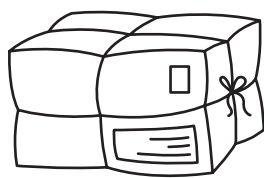

K/k: Wörter



Schneide aus und klebe!

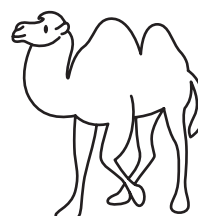
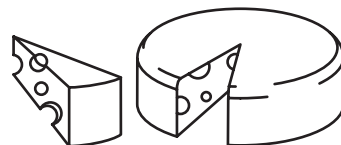
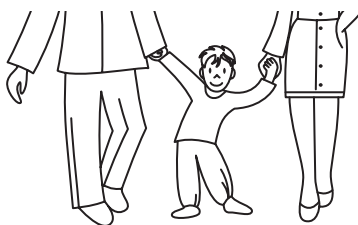

Ka mel



Kro ne



Kä fer



Kö nig



Ker ze



Kä se



Kind



Pa ket



K/k: Wörter

Schneide aus und klebe!

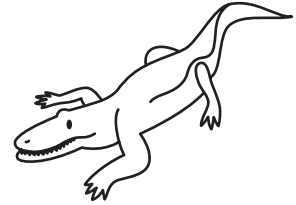
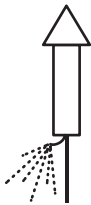
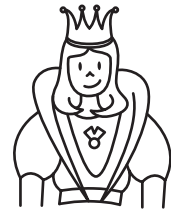
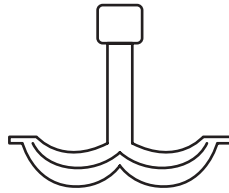
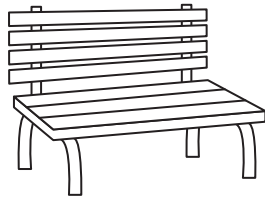

Anker



Bank



Kasperle



Krokodil



Königin



Rakete



Pelikan



Kleid





K/k: Wörter schreiben

Schreibe und kontrolliere!

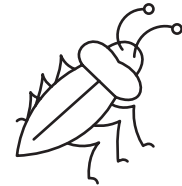
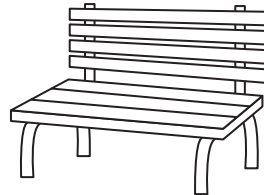
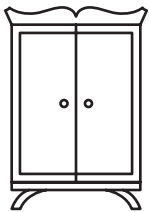
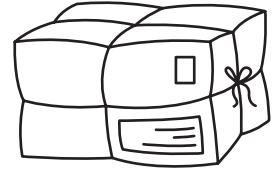
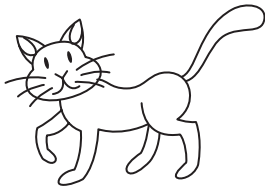

Katze

Kontrolliere!

Paket

Schrank

krank

Kind

Bank

Käfer

Kopf



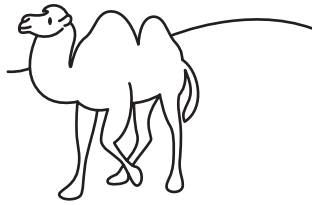

Lies, klebe,
male fertig!

K/k: Sätze

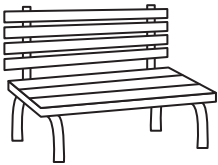

Ka rin sitzt auf der Bank.



Ka rin im li la Kleid.



Ka rin hat ei ne Kro ne.



Zwei Ka me le sind in der Wüs te.